

New Jersey Barricade OR L Type Barricade

Front View

Back View

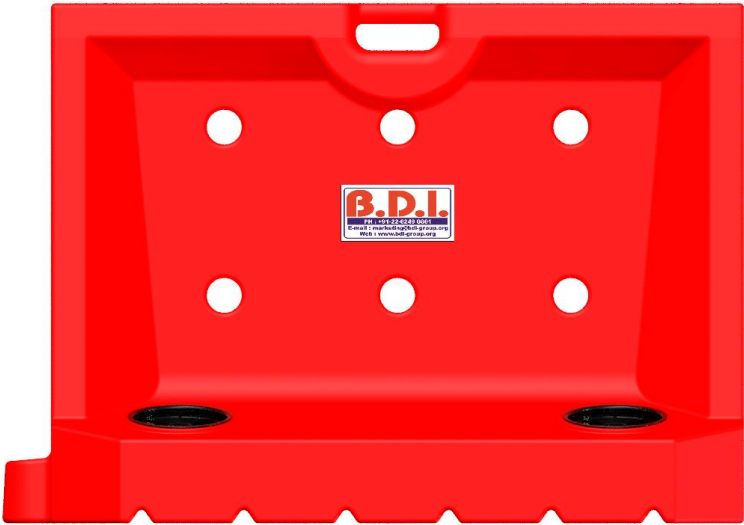
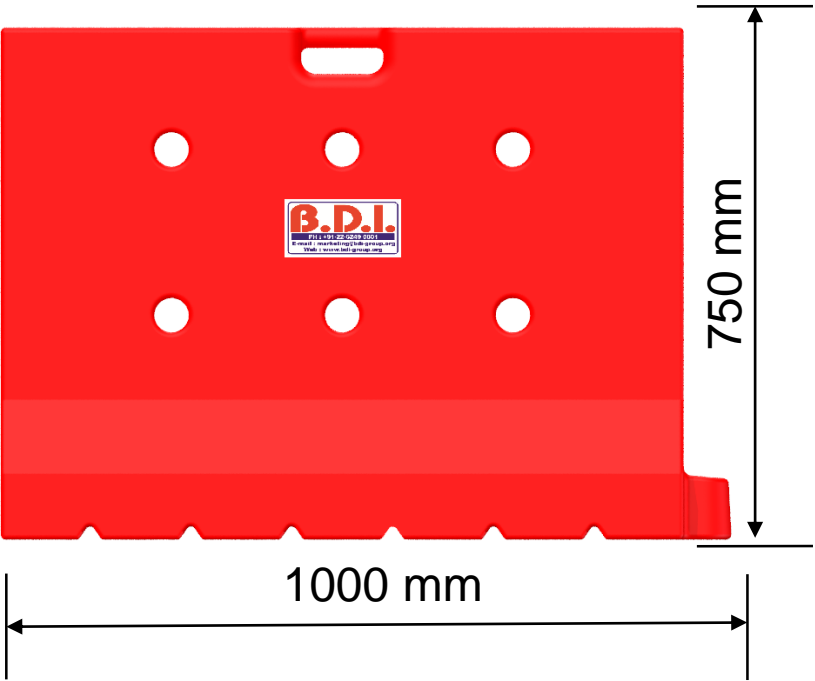

New Jersey Barricade OR L Type Barricade

- Material : High durable virgin premium grade Polyethylene material
- UV Stabilized
- Anti-static properties.
- Can withstand the high wind pressure.
- No rust, No chip, No peel.
- Completely maintenance free
- Provision for fixing retro-reflective sheet in an embossed position .
- Pasting retro reflective sheet helps prevent vandalism, and enhances high visibility during the night.
- The interlocking capability of this barriers helps in linking to form a chain.
- the provision of handle helps in lifting the barricades easily.

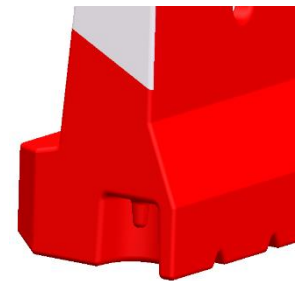
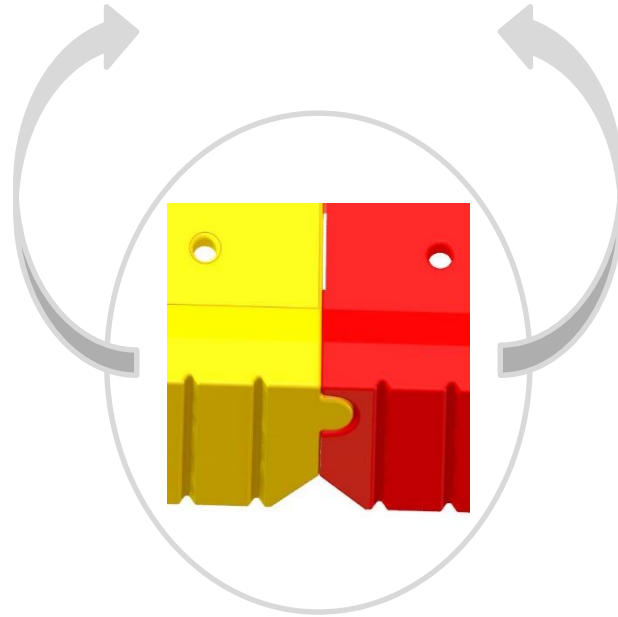
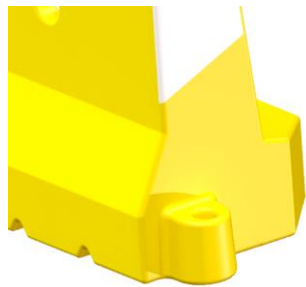
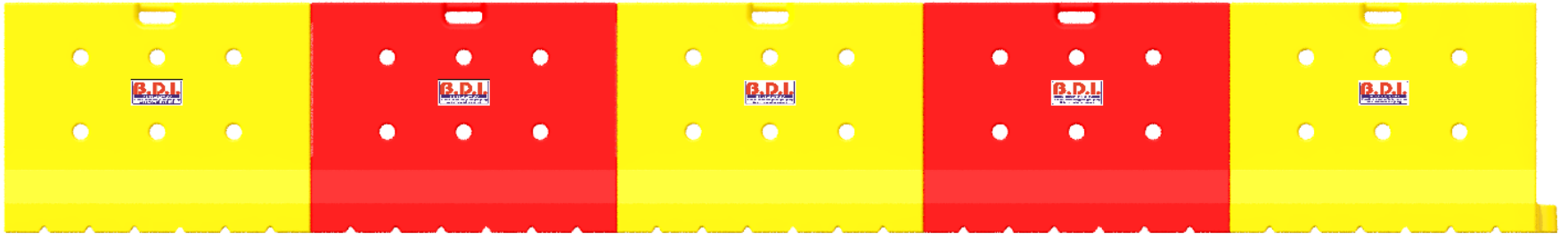

Interlocking Provision

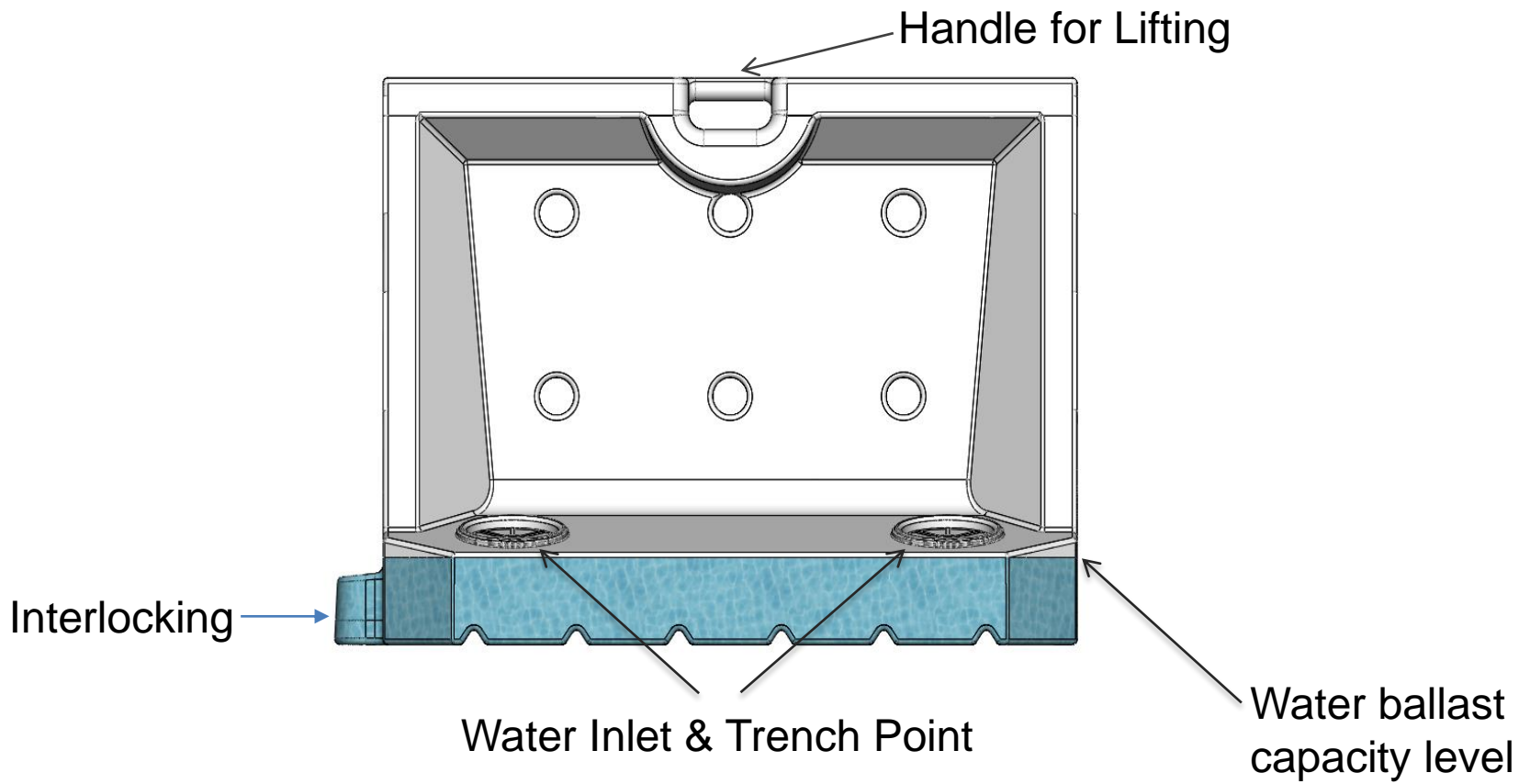

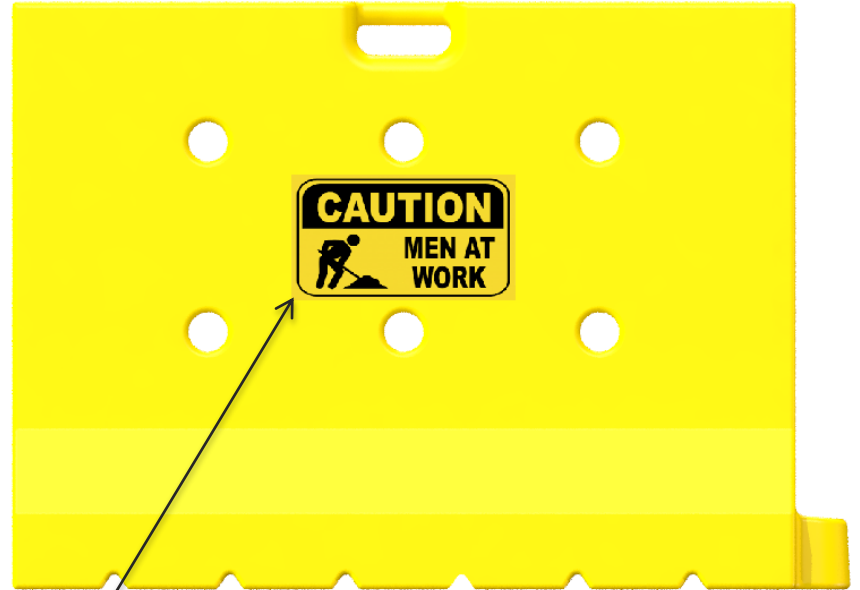
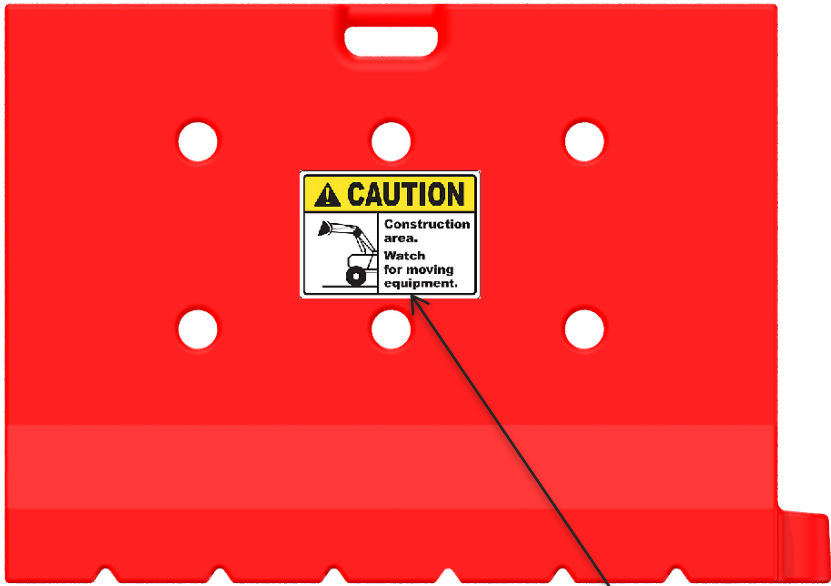

Space provided for sticker / Logo

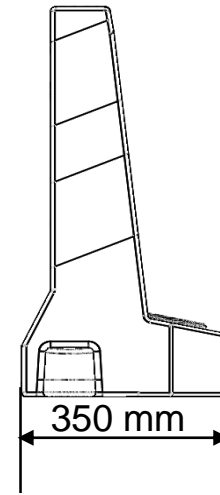
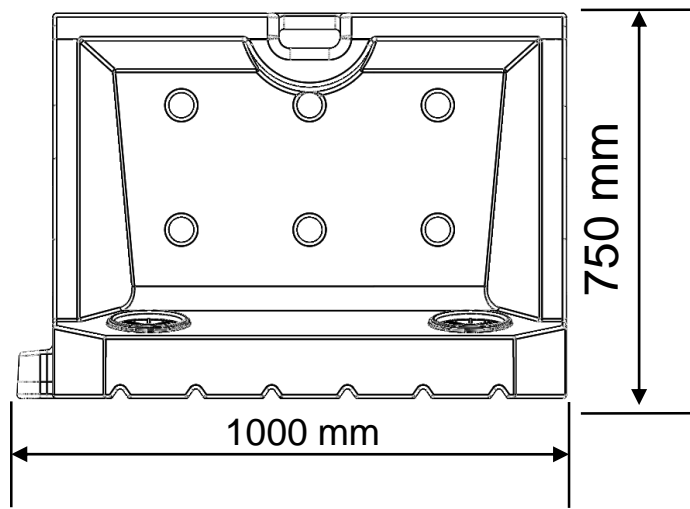

Length	1000mm
Width	350mm
Height	750mm
Water Ballast Minimum	35 Ltrs
Non Fading Color	Yes
UV Stabilized	Yes
Interlinking Provision	Yes
Drain Plug	Yes
Retro Reflective Color	Red / White
Barrier Color Availability	Red / Yellow
Sticker Pasting Slot	Available
Sticker pasting Slot size	500mm x 175mm

Site Photo



THANK YOU