

SMART DOORLOCK

SERIES-1PRO WIFI

 phlipton
automation



Configuration Video

www.phlipton.com

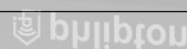
 phlipton
automation

UNIQUE FEATURES

⚙️ FAST FINGERPRINT SENSOR

50 fingerprints can be registered in this lock and unlocking speed is 0.5 seconds only.

⚙️ RFID CARD

100 RFID card can be registered in this lock, the RFID card is specially designed for this lock only for your security.

⚙️ PIN OPTION WITH VERY FINE TOUCH KEY PAD

You can register 100 pins in this lock and the Touch Key Pad is very fine to Use.

⚙️ LOW BATTERY INDICATION

The lock will give you an indication on the screen that the battery is low.

⚙️ RECORD HISTORY

You can Check Past Unlocking Records.

⚙️ EMERGENCY POWER

In case the battery is completely discharged, an external 5V Micro USB type cable can be used to give power to the lock.

⚙️ AUTO LOCKING SYSTEM

The lock will eliminate the manual locking as it will get locked automatically when the door gets closed.



PRODUCT PARAMETER

Power Supply : 4.5V-6V (4 pcs AA Cell power)

**Unlock Methods : Fingerprint / RFID card
Passcode / Mechanical Key / Application**

Quiescent Current : <50-65uA

Passcode Length : 6-8 Bits

Card Volume : 100 pcs

Password Volume : 100 pcs

Finger Volume : 50 pcs

Administrator : 9

Lower Voltage Alarm : 4.5+0.2V

Operating Temperature : -10 °C~60 °C

Door Thickness : 38-120mm

Material : Aluminium Alloy

Size : 370*70*65MM (INDOOR/OUTDOOR)



USER MANAGEMENT

1. Initialization

Press the set button (rear panel button) for 5 seconds. Voice will remind : Initialization successfully.

note: Initialization password is: 123456, or any fingerprint can unlock the lock.

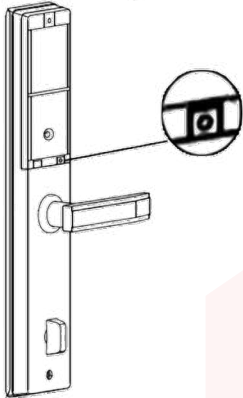

Long press the back lock setting key, the countdown is over in 5 seconds, release and restore the factory setting successfully

2. Add Administrator information (Up to three administrator users)

→ Confirm

* → Back

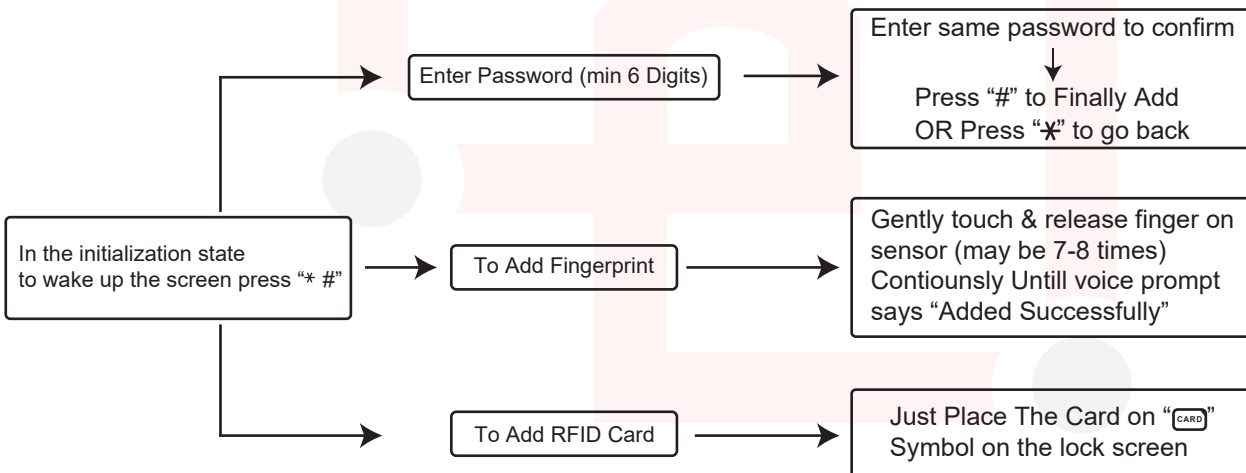

3. Language Settings

Press "*" # on touch pad

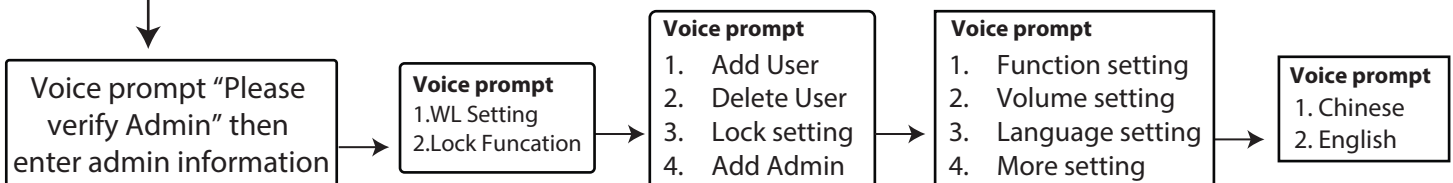

USER MANAGEMENT

4. Add General User Information

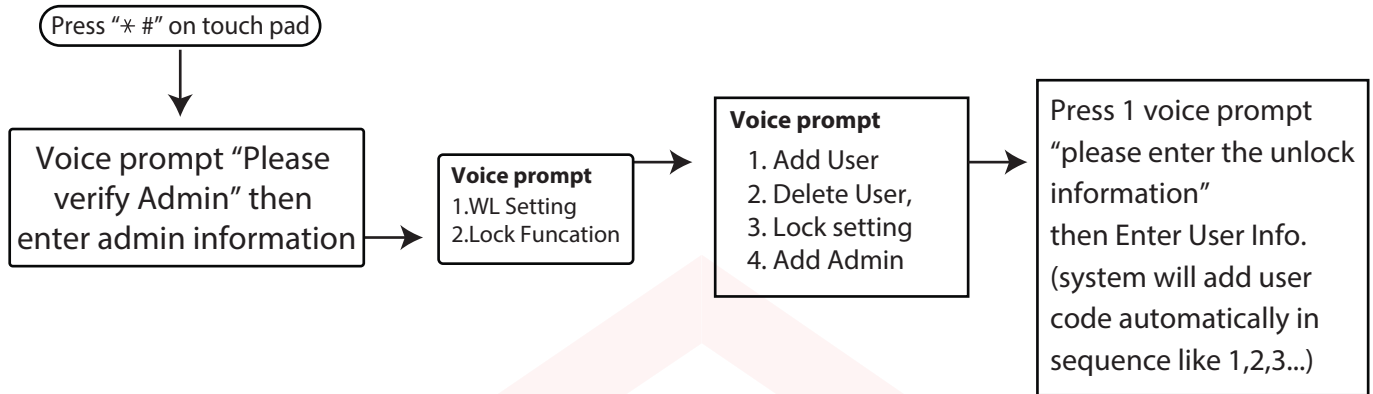

5. Delete User information

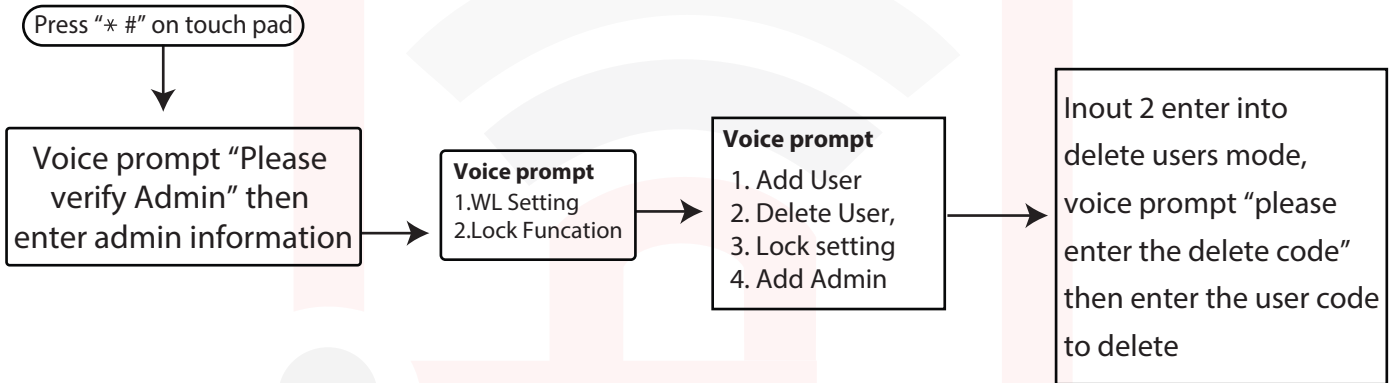

6. Normally Unlock / Passage mode

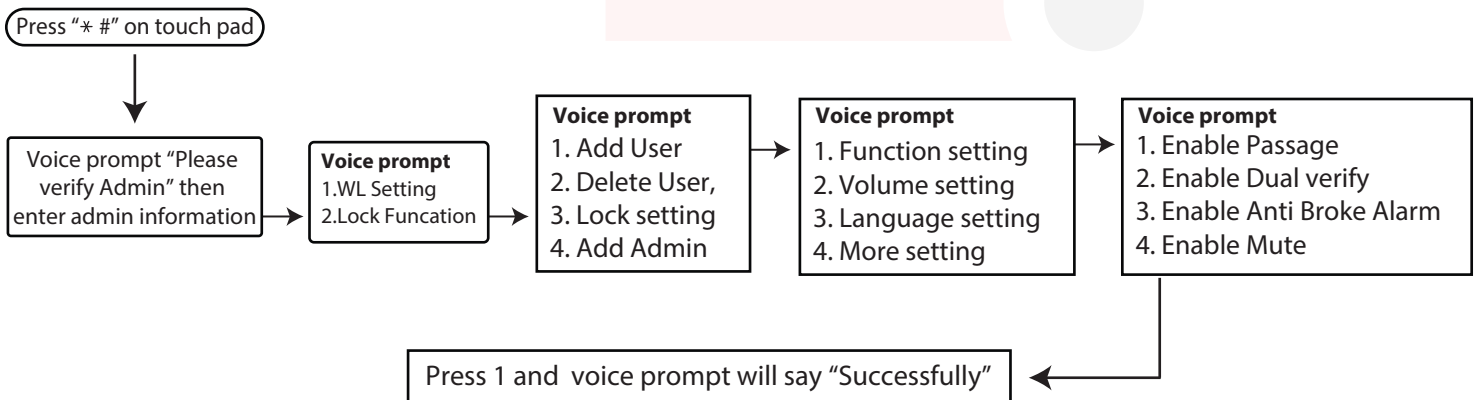

Note: After the normally open mode is turned on, every unlocking is normally open mode, and the lock will not be automatically closed, so it is necessary to manually unlock the lock once.

6. Connect to Application

Press “* #” on touch pad

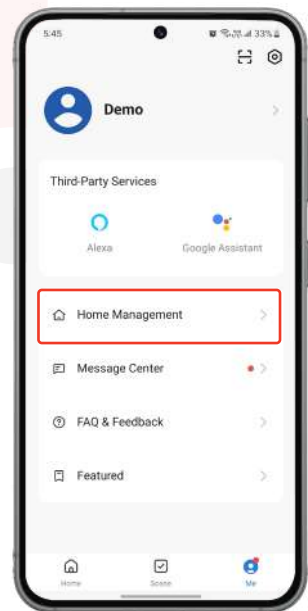
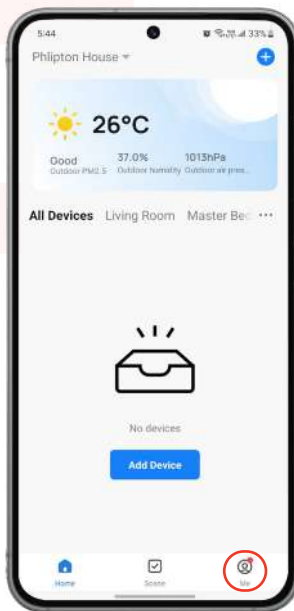
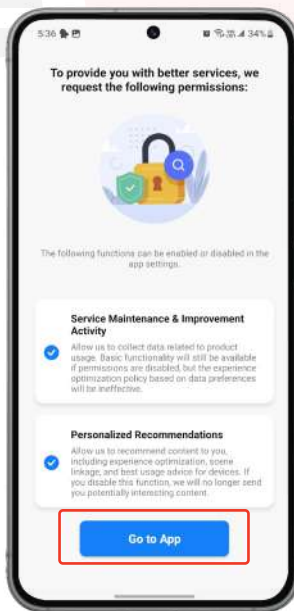
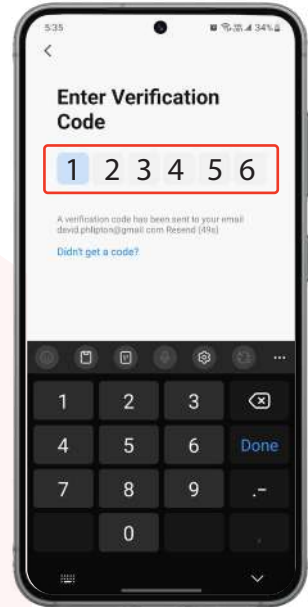
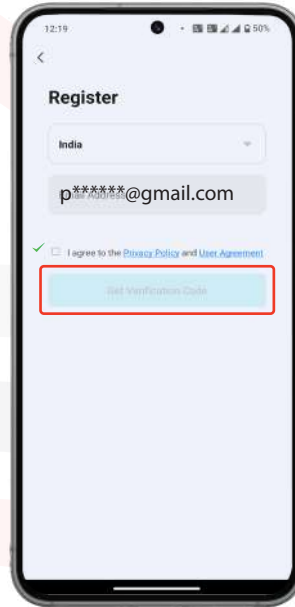
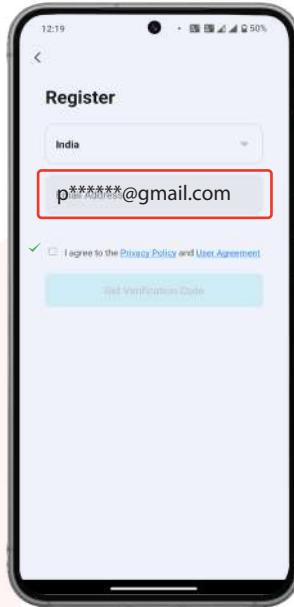
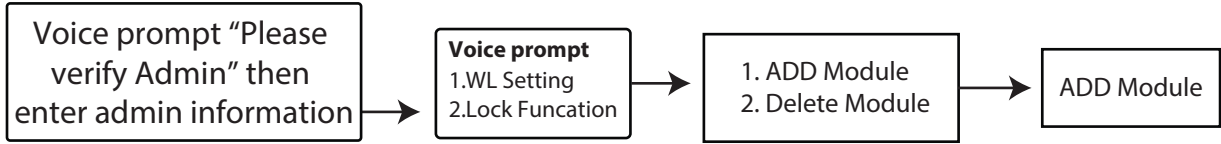

6.Connect to Application

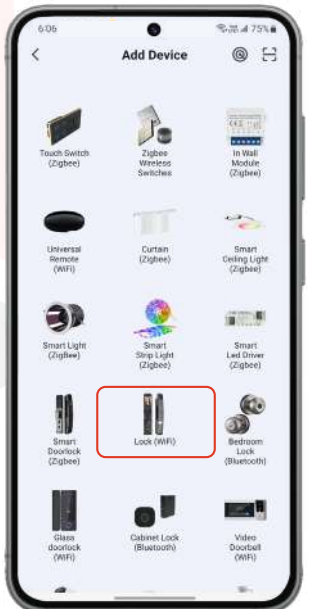
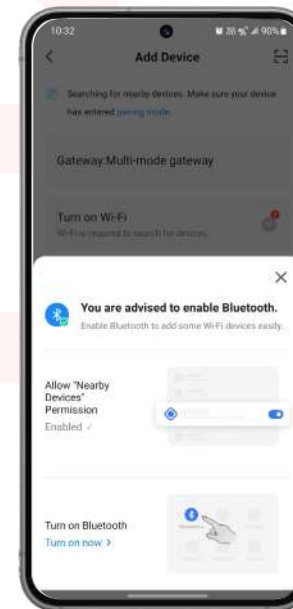
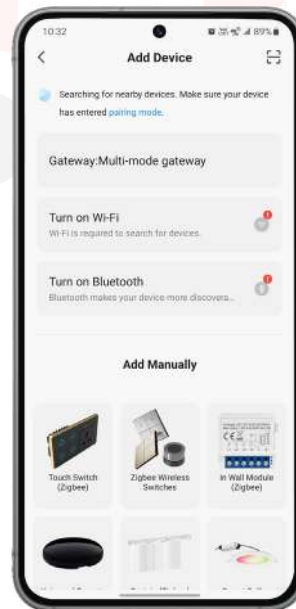
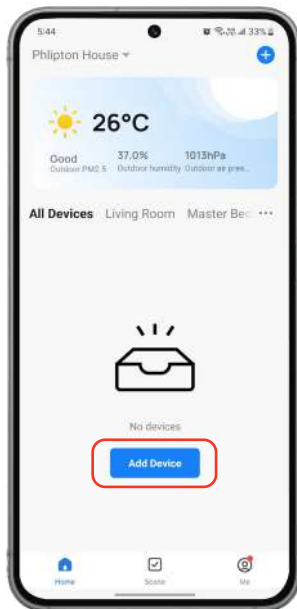
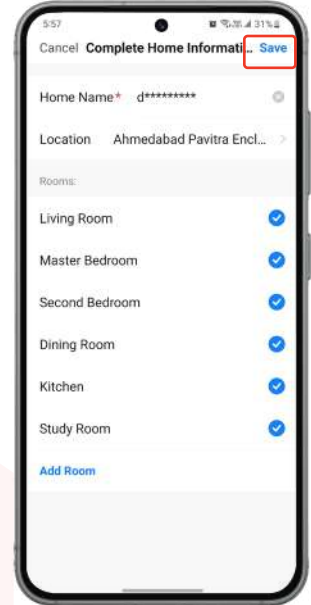
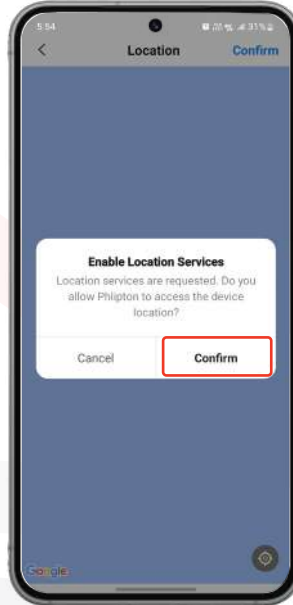
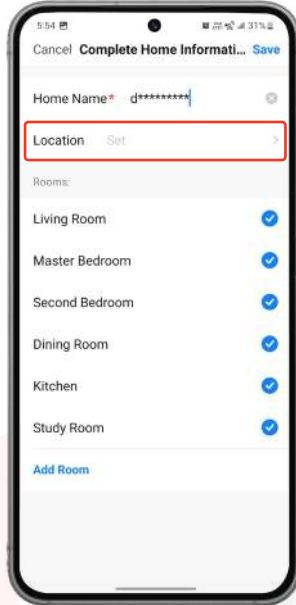
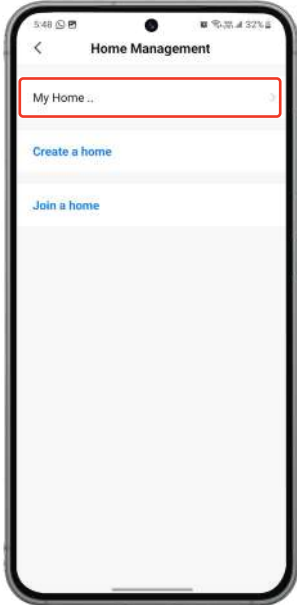

6. Connect to Application

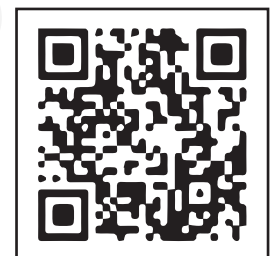
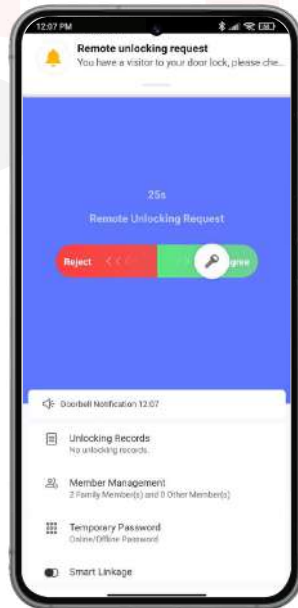
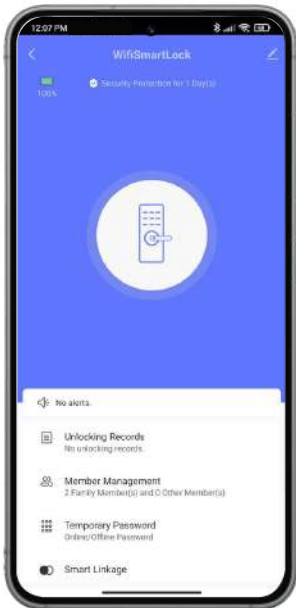
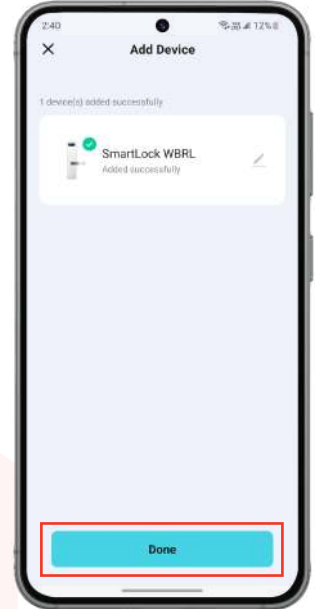

APPLICATION LINK

Semi Installation Diagram

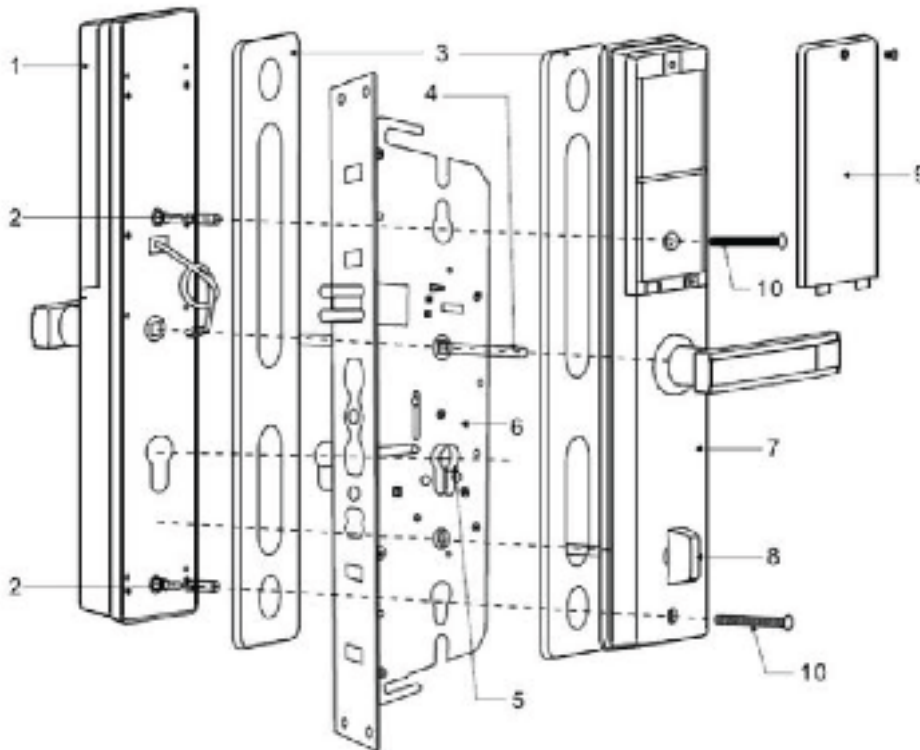

1. front panel
2. connecting pipe
3. silicone pad
4. Fangxin
5. lock cylinder
6. lock body
7. Rear panel
8. Indoor locking knob
9. battery cover
10. Screw-fitting.

Note: When installing semi-automatic lock, adjust the clutch and direction of handle according to the direction of door opening.



SMART DOORLOCK

SERIES-1PRO WIFI



Download Phlipton App



www.phlipton.com

Follow us :    

